

REVISIONS				
ZONE	REV.	DESCRIPTION	DATE	APPROVED
	A	PART: Slant back configuration DWG: Updated notes	3/24/2008	BN

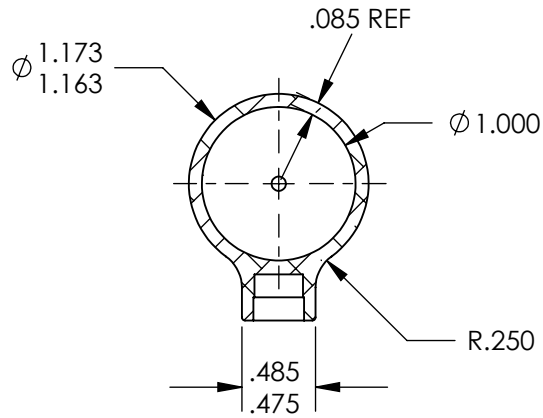

SECTION B-B

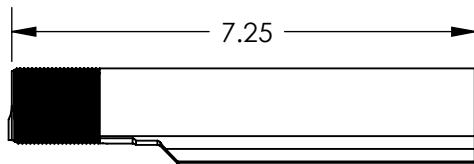
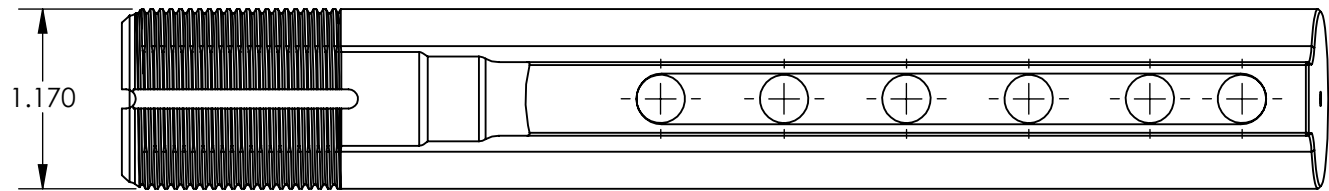
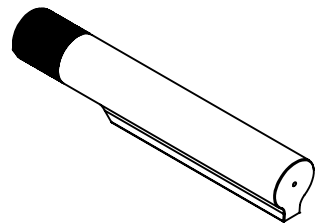
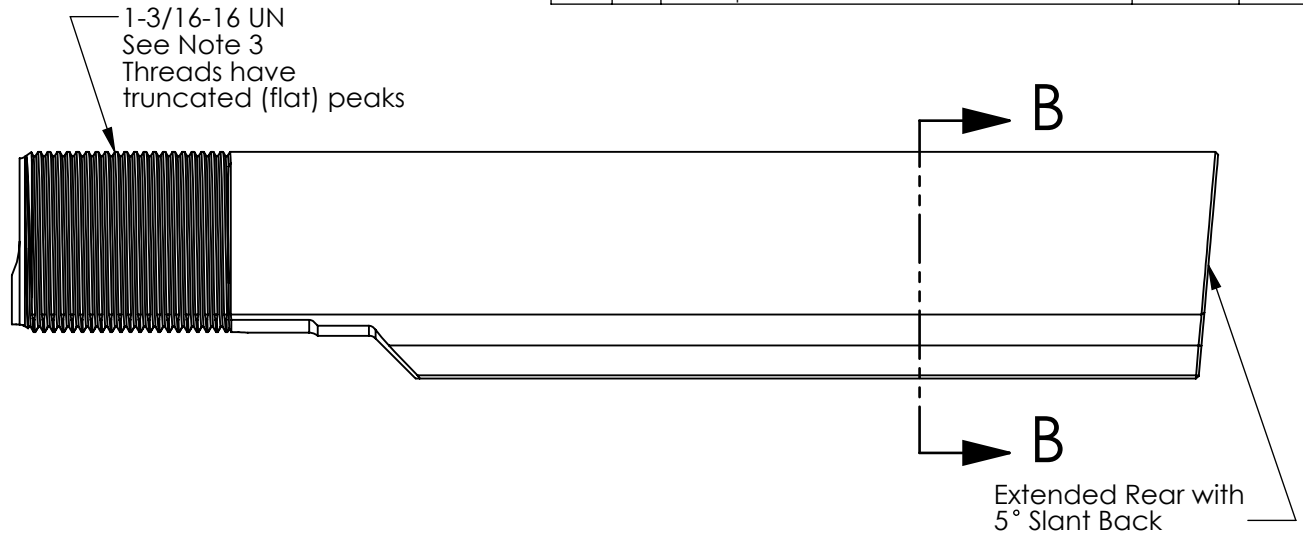

Standard Length (Flat Back)

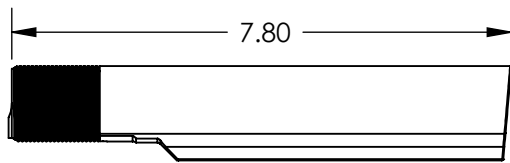

Extended Length (Slant Back)

NOTES

1. MATERIAL: 6061-T6 Extrusion
2. FINISHING: Hard anodize
3. PART ID: Threads have truncated (flat) peaks and measure equal or less than tube diameter of approximately  $\phi$  1.170.
4. COMPATIBILITY: Tube diameters between  $\phi$  1.160 and  $\phi$  1.175 may be used with the Commercial models of the CTR, MOE and ACS stocks. M4 Receiver Extensions are not compatible with the UBR or PRS stocks.

DIMENSIONS ARE IN INCHES		NAME	DATE	PART NAME
TOLERANCES: FRACTIONAL $\pm$ 1/16 ANGULAR: MACH $\pm$ 2 BEND $\pm$ 4 TWO PLACE DECIMAL $\pm$ .020 THREE PLACE DECIMAL $\pm$ .004 FOUR PLACE DECIMAL $\pm$ .0005		DRAWN	EN	3/24/2008
MATERIAL Al 6061-T6		CHECKED	BN	3/24/2008
FINISH Hard Anodize, Black		ENG APPR.		
DO NOT SCALE DRAWING		MFG APPR.		
		Q.A.	ML	3/24/2008
		<b>PROPRIETARY AND CONFIDENTIAL</b>  <b>MAGPUL INDUSTRIES CORPORATION</b>		
		SIZE	DWG. NO.	REV.
		A	-	A
		SCALE: 1:1.25		WEIGHT: 0.326 lbm
		SHEET 1 OF 1		

PARTIAL DRAWING - only critical dimensions and fits are noted. All other dimensions per file: **M4 Receiver Extension, Carbine, Commercial**